

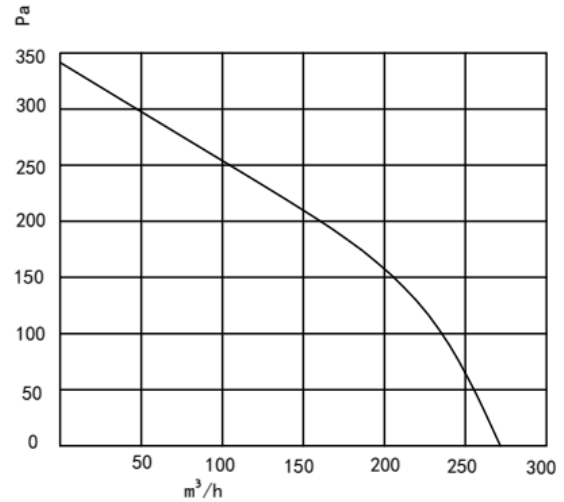

SIZE: $\phi 120\text{mm}$

- Impeller Material: Galvanized Metal Sheet
- Speed Control: 0-10VDC/PWM
- Motor Type: Brushless DC External Rotor Motor
- Type Of Protection : IP44
- Insulation Class: B



Technical parameter

Model Type	Rated Voltage (V)	Frequency (Hz)	Rated Current (A)	Rated Power (W)	Rated Speed (RPM)	Air Flow (m³/h)	Air Pressure (Pa)	Noise Level (dB(A))	Perm.Amb. Temp. (°C)	Weight (Kg)
K-EC120-F230-24	230	50/60	0.55	60	2400	270	340	65	-25~+60	1.1

Outline drawing

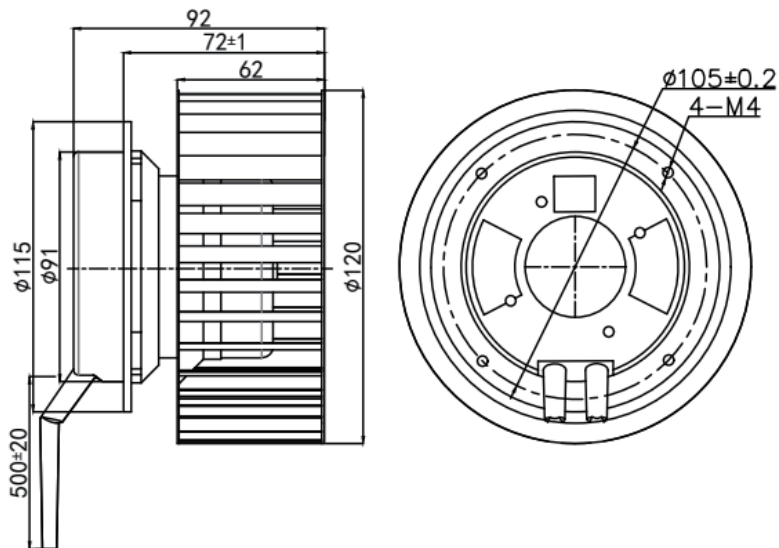

Power Cord	Colour	Brown	Blue	Y/G
AC Power Cable	Function	L	N	PE
Colour	Red	Blue	Yellow	White
Function	+10V Out put	GND	0-10VDC/PWM	FG