

KRUBO DC 120*38MM BITCOIN MINING EQUIPMENT COOLING FAN

Krube

HOT SELLING MODELS K-DC12038-A12 SERIES

Krube K-DC12038-A12 Series is 12V DC Compact Fan, The cooling fan is specifically designed for Bitcoin mining equipment, featuring ultra-long-life dual ball bearings to ensure continuous 24-hour cooling, and is equipped with 4 wires for precise monitoring and control of the fan speed.



MAIN APPLICATION PRODUCTS:

ASIC Miners, GPU Miners

KRUBO ADVANTAGES:

We leverage our professional industry experience and high-quality products to provide you with convenient one-stop service.



sales1@krubofan.com

Whatsapp: +86 183 1038 2612



- Material--Frame: Plastics,(Flammability:UL94V-0)
Impeller: Plastics (Flammability:UL94V-0)
- Lead Wire: +Red,-Black.
- Optional Function: FG Yellow(speed feedback),
PWM Blue(speed control).
- Life Time: 40,000~70,000 Hours
- Bearing Type: Double ball bearing
- Rated Voltage: 12V DC
- Rated Speed: 4000~9600 RPM
- Rated Airflow: 111~247 CFM

Model No.	Rated Voltage	Operating Voltage	Rated Current	Rated Input Power	Speed	Max. Air Flow		Max. Static Pressure		Noise
	VDC	VDC	A	W	R.P.M	m ³ /h	CFM	mm H2O	inch H2O	dB-A
K-DC12038-A12-40H	12	7.2~13.8	0.5	6.1	4000	3.38	118.96	15.03	0.592	52.5
K-DC12038-A12-50H			1.3	15.6	5000	5.14	181.61	21.11	0.831	59.4
K-DC12038-A12-55H			1.7	20.4	5500	5.69	201.17	25.61	1.008	62.6
K-DC12038-A12-60H			2	24	6000	6.6	217.62	29.65	1.67	63.5
K-DC12038-A12-70H			3.4	40.8	7000	5.94	209.1	42.83	1.68	64.5
K-DC12038-A12-76H			4.2	50.4	7600	6.44	226.89	51.11	2.01	68.5
K-DC12038-A12-95H			7.4	88.8	9500	7.78	274	116.8	4.6	78
K-DC12038-A12-96H			4	48	9600	7	247	97	3.82	70.5

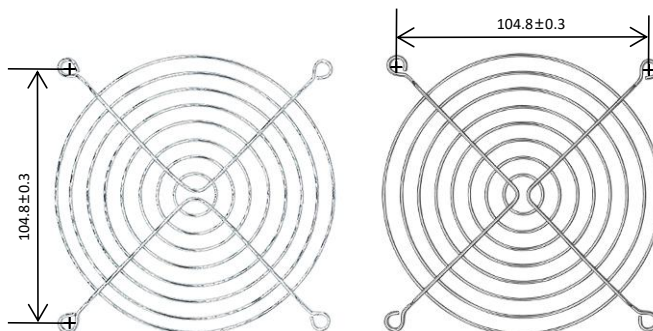
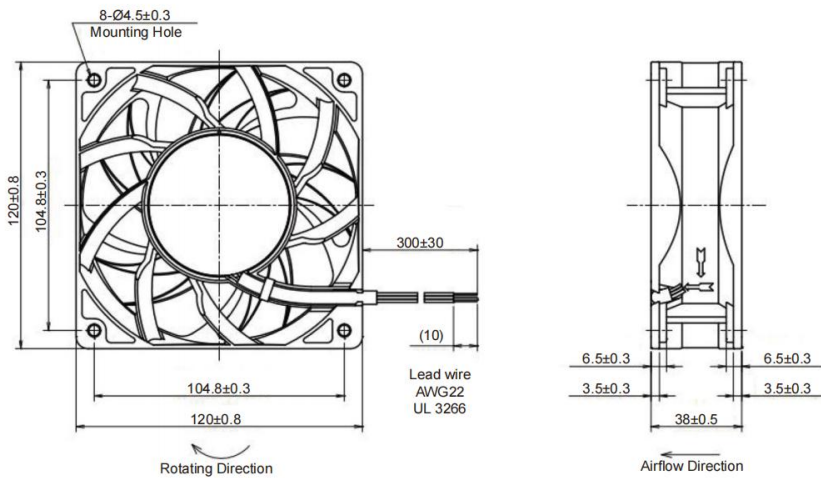

K-DC12038-A12-40H

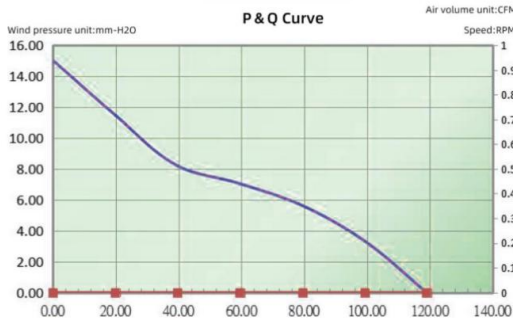

K-DC12038-A12-50H

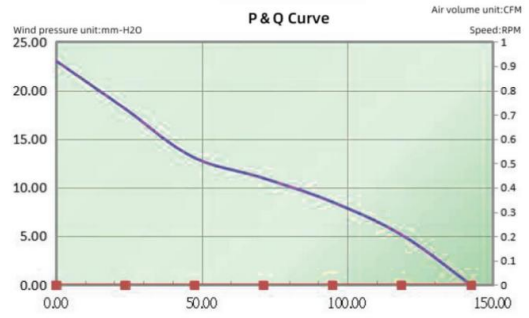

K-DC12038-A12-60H

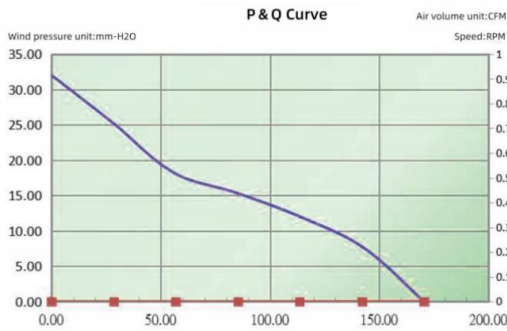

K-DC12038-A12-70H

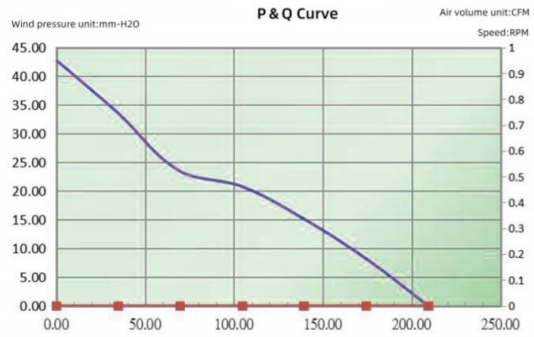

K-DC12038-A12-76H

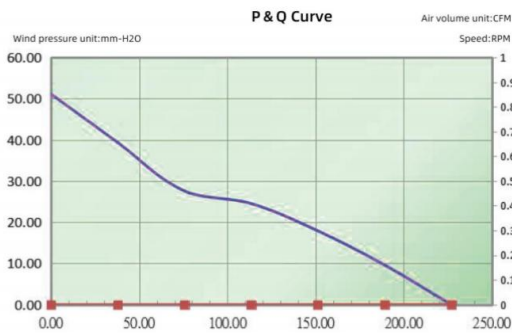

High Speed Models

K-DC12038-A12-95H (Line ①)

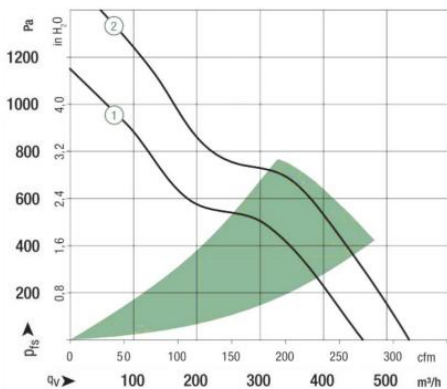

K-DC12038-A12-96H

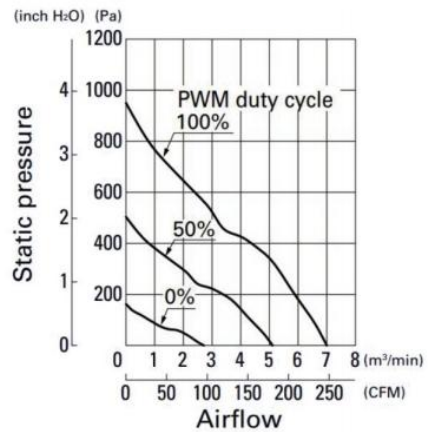

About Us:

Factory Show

Krube

20,000 m²
Manufacturing
Base

100⁺
Countries
Regions

6,000⁺
Customers

80,000⁺
Capacity

KRUBO adheres to the principle of "high starting point, high standard and high requirements", takes customer satisfaction as the standard, and "cooperation, win-win and innovation" as the eternal pursuit. Focus on building smart and energy-saving technology, and strive to become the world's first brand of smart, energy-saving and





Over 20,000
Manufacturing Base

.....>>>>>> R&D Team <<<<<<<.....



Design team



Design team



Design team



Design team

Multiple Test

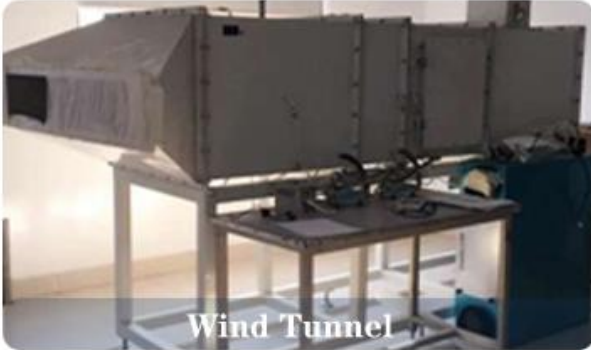

Contact Info

-Web: <https://en.krubofan.com>

-Email: sales1@krubofan.com

-Whatsapp/Wechat/Mobile: +86 183 1038 2612

-Add: Address:38 Fagang South Road, Jinnan District, Tianjin